

## 2J6024B

### CELLULAR/LTE Screw Mount

#### Key Features

##### Cable 1: CELLULAR / LTE

- 698-960 MHz
- 1710-2170 MHz
- 2500-2700 MHz

Screw Mount

Low Profile

Ground Plane Independent

Customizable Cable and Connector

Dimensions 80 x 74 x 14.7 mm

Certificates: IP67



## 1. Antenna and electrical specifications

Cable 1

Parameters	CELLULAR / LTE Antenna		
<b>Standards</b>	2G,3G and 4G		
<b>Band (MHz)</b>	700/850/900	1700/1800/1900/2100	2600
<b>Frequency (MHz)</b>	698-960	1710-2170	2500-2700
<b>Return Loss (dB)</b>	~-11.6	~-8.7	~-18.4
<b>VSWR</b>	~1.9:1	~2.2:1	~1.3:1
<b>Efficiency (%)</b>	~37.9	~35.1	~42.3
<b>Peak Gain (dBi)</b>	~1.8	~3.5	~4.4
<b>Average Gain (dB)</b>	~-4.3	~-4.6	~-3.8
<b>Impedance (Ohm)</b>	50		
<b>Polarisation</b>	Linear		
<b>Radiation Pattern</b>	Omni-Directional		
<b>Max. Input Power (W)</b>	25		
<b>Connector Type</b>	SMA-Male Standard (Other Connectors Available)		
<b>Cable Length</b>	300 cm Standard (Any Cable Length Available)		
<b>Cable Type</b>	DACAR302 Standard (Other Cables Available)		

### Antenna Measurement Conditions:

Mounted on 30 x 30 x 0.25 cm ABS Plate

200 cm of Cable DACAR302

Measured in Certified CTIA 3D Anechoic Chamber

## 2. Mechanical and environmental specifications

Specifications	2J6024B
<b>Mounting Type</b>	Screw Mount
<b>Dimensions (mm)</b>	80 x 74 x 14.7
<b>Radome</b>	ABS
<b>Radome color</b>	Black
<b>Operating Temperature (C)</b>	-40 to +85
<b>Storage Temperature (C)</b>	-40 to +85
<b>Substance Compliance</b>	RoHS
<b>Certificates</b>	IP67

### 3. Antenna parameters

Cable 1: CELLULAR/LTE

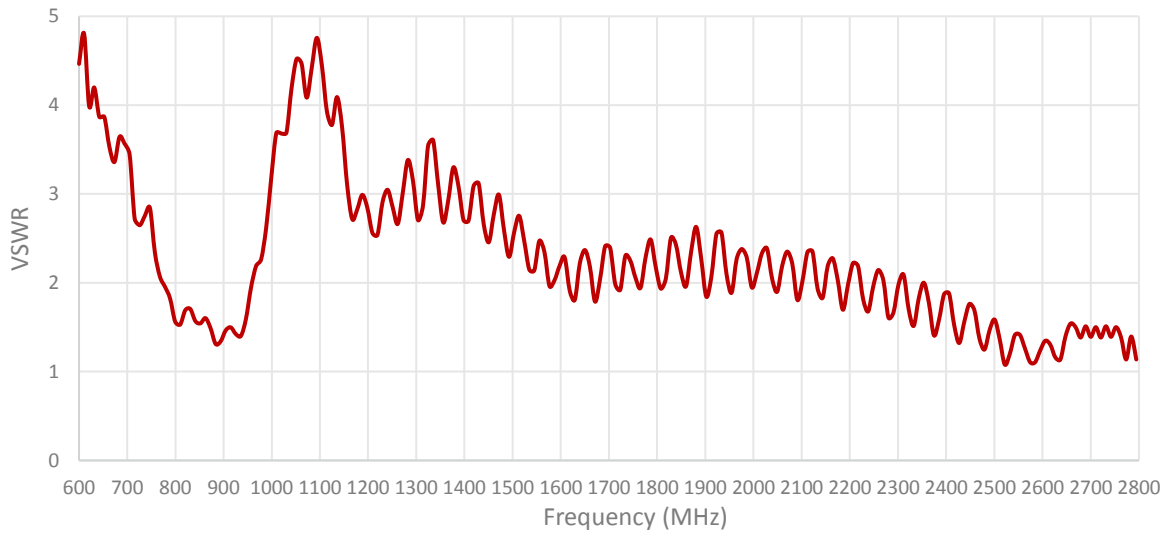
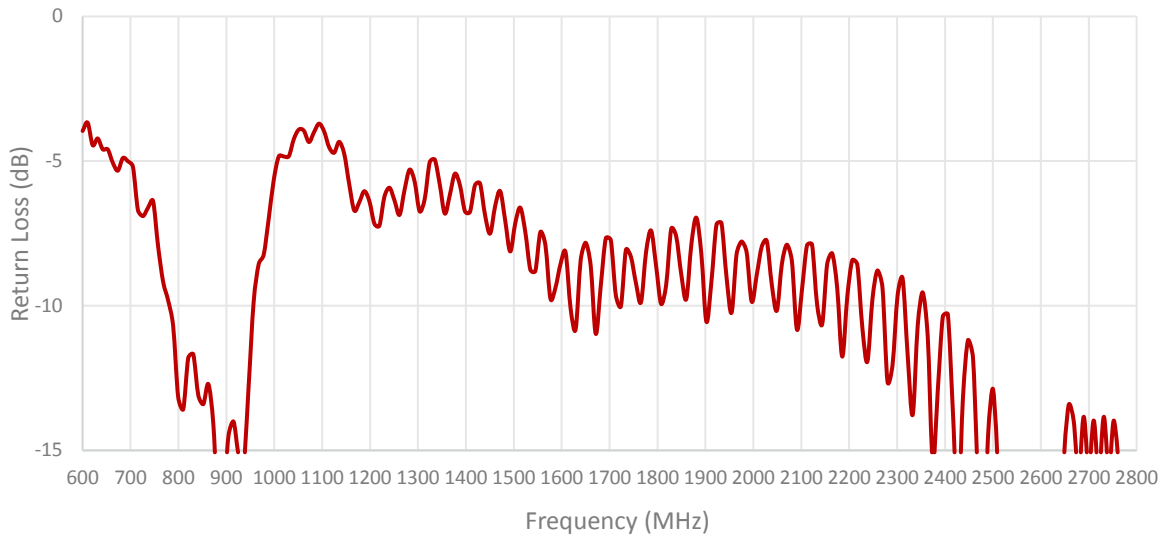

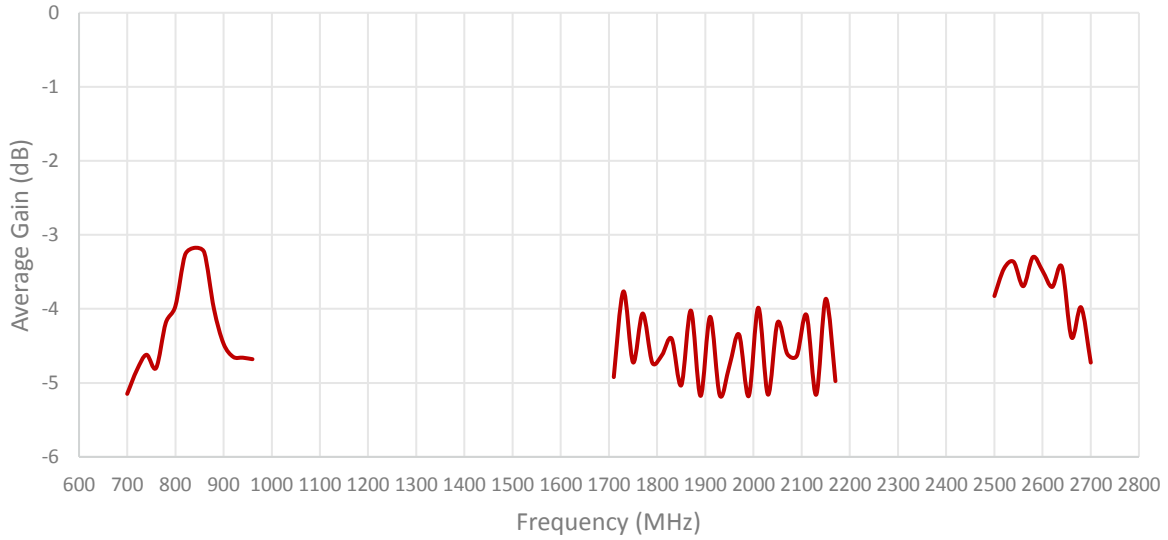
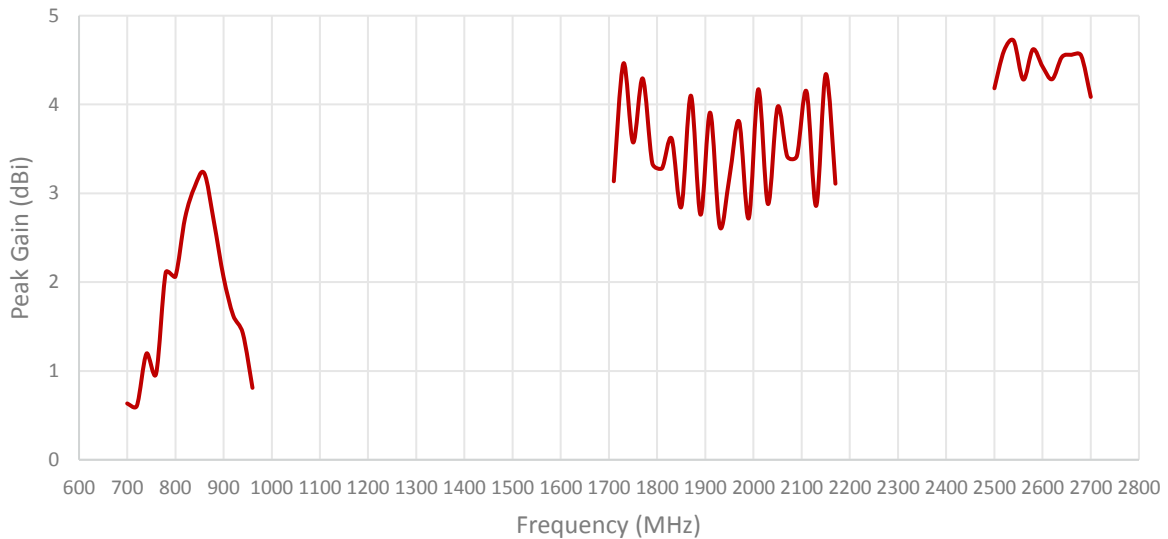
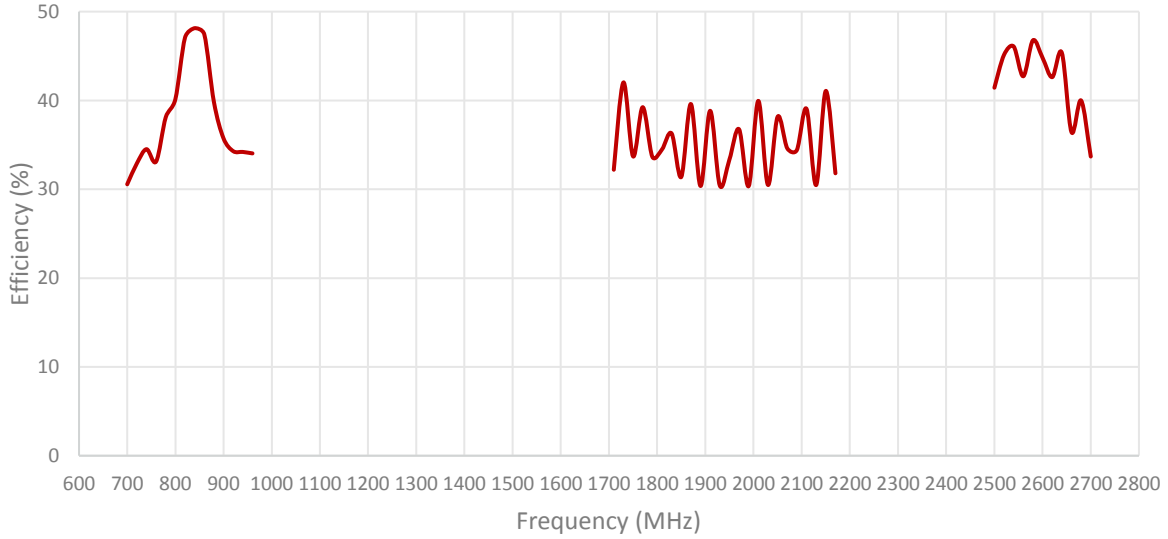

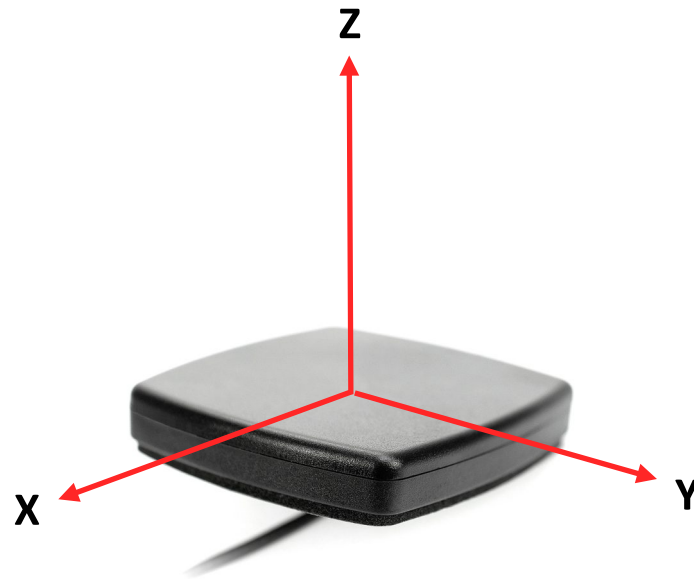

Radiation pattern reference

Cable 1: CELLULAR/LTE

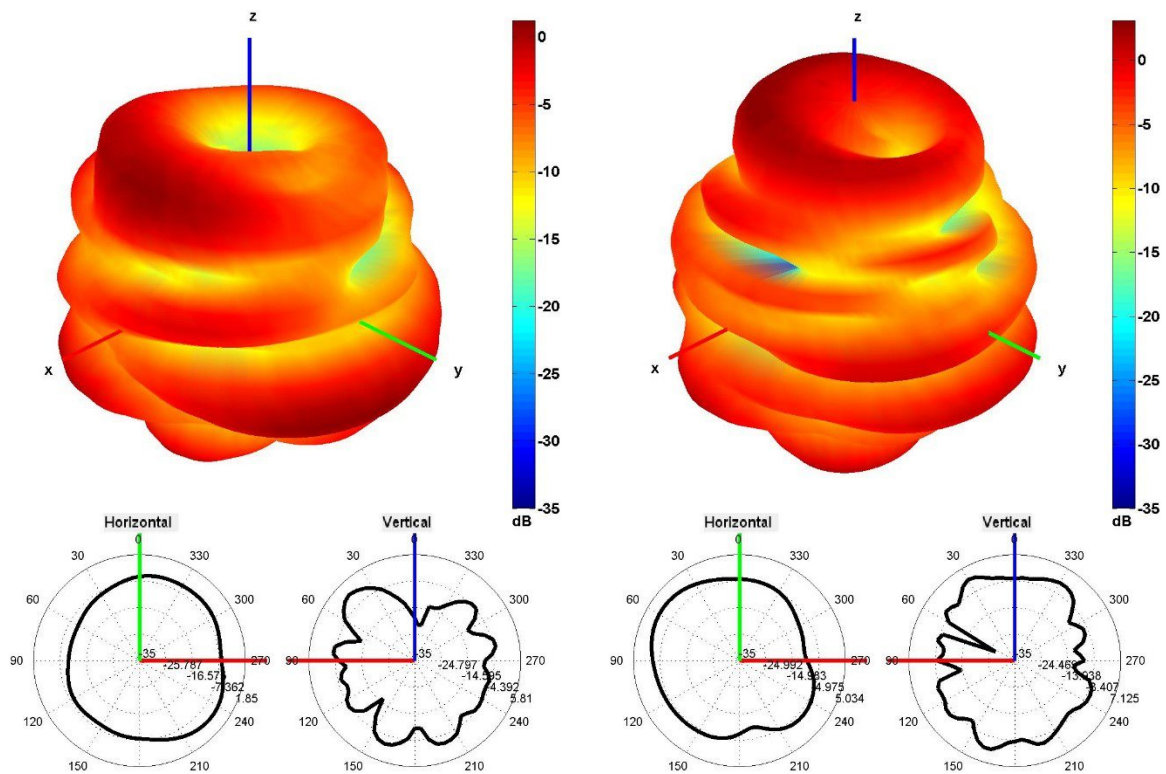

750 and 850 MHz Radiation pattern

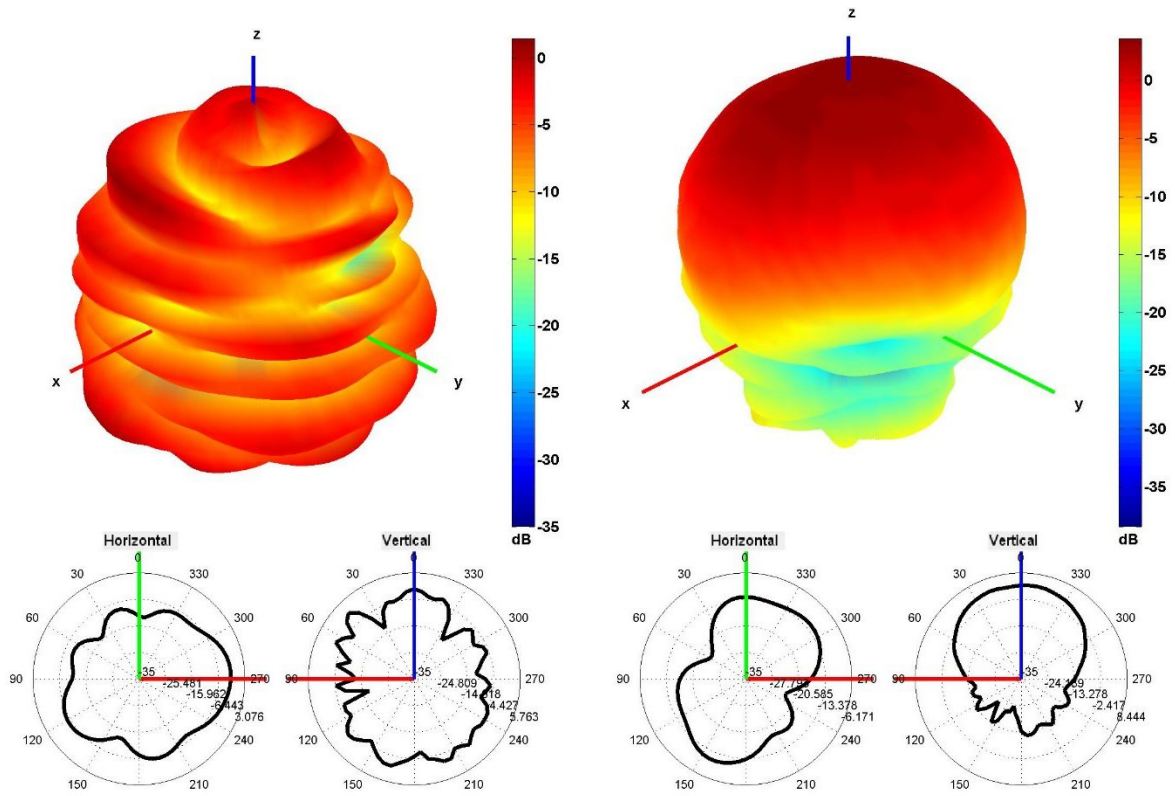

940 and 1750 MHz Radiation pattern

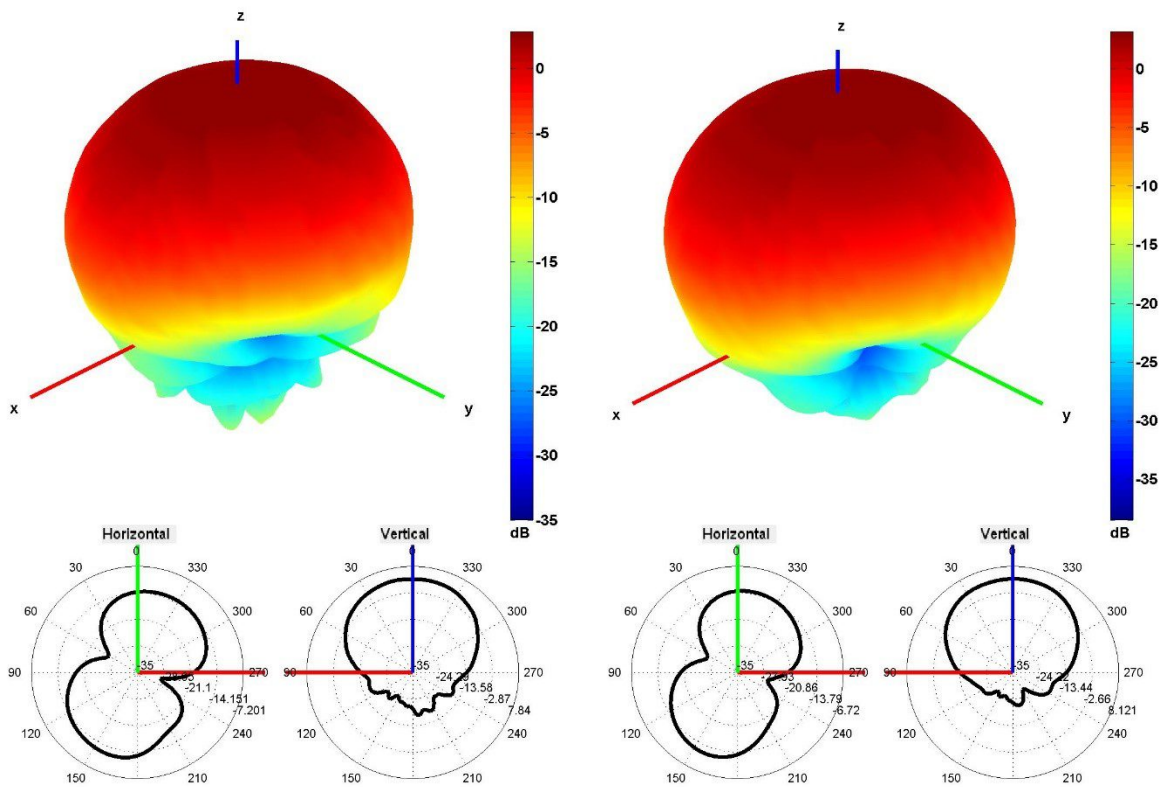

1850 and 1950 MHz Radiation pattern

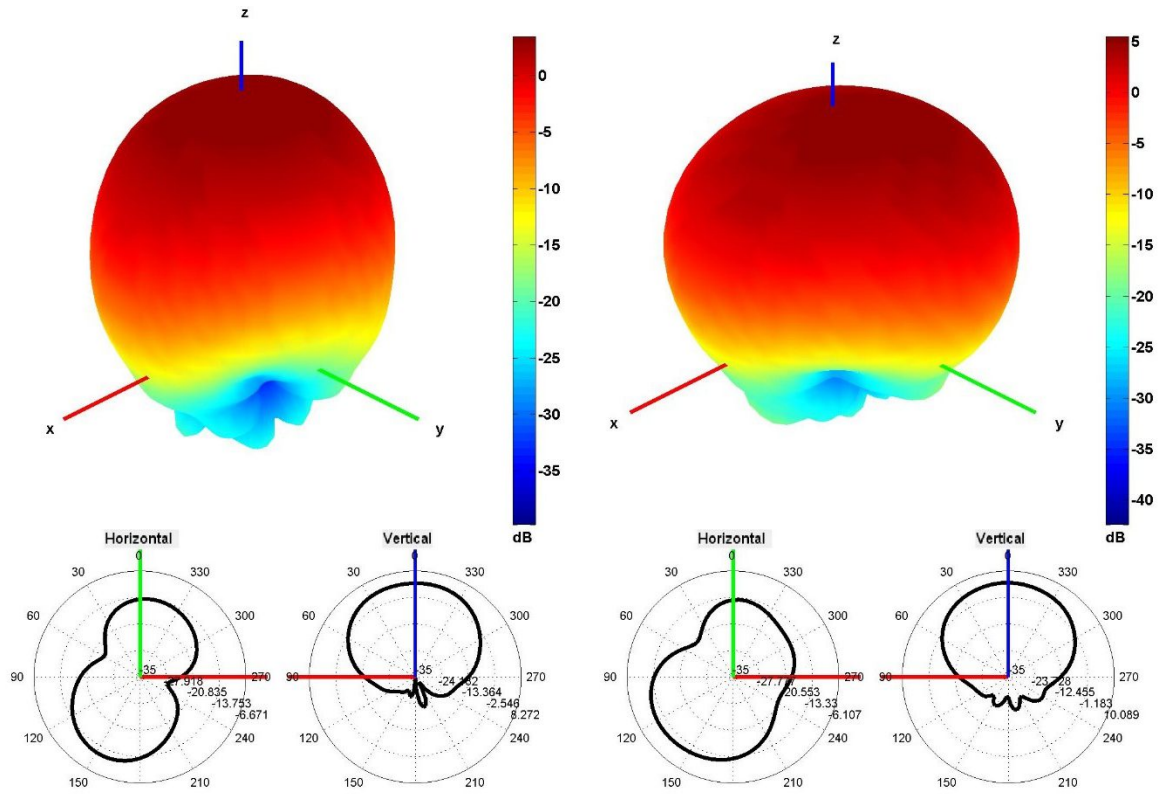

2100 and 2600 MHz Radiation pattern

## 4. Antenna drawings

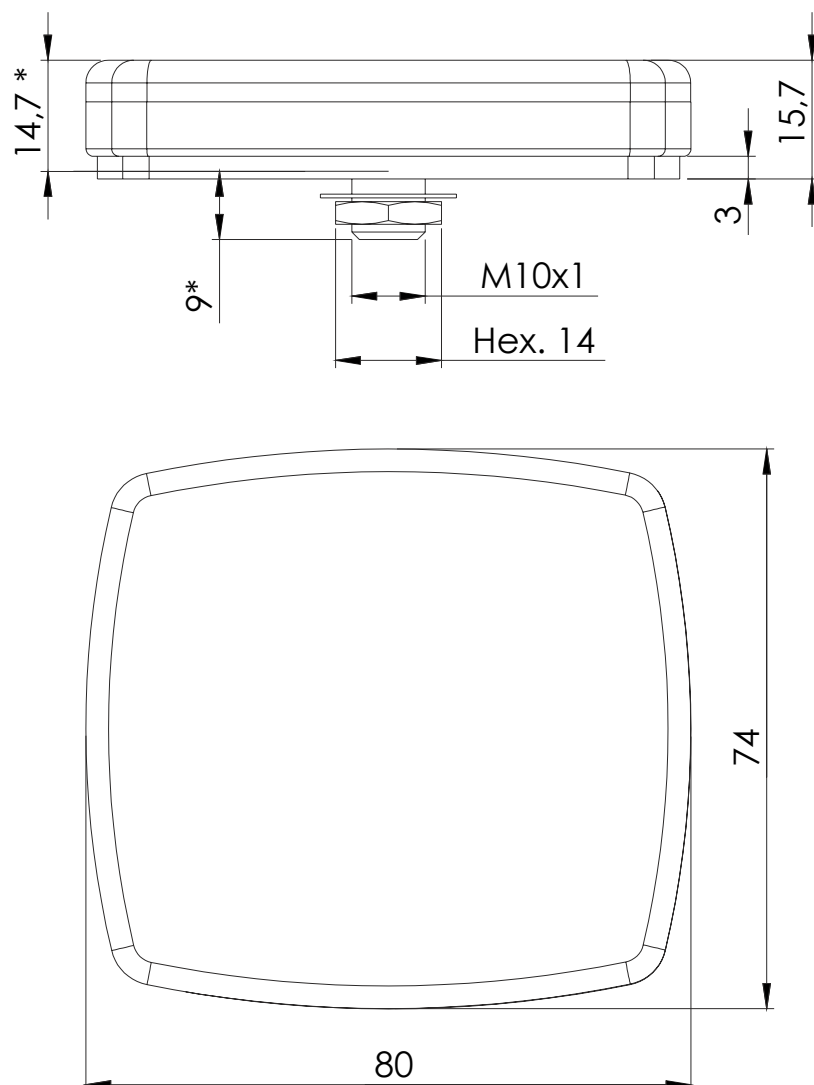

\* Dimensions after mounting



## 5. Antenna Images

